

INFINUVO

CleanMate 365

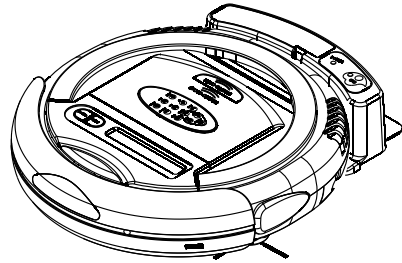

CleanMate 365

Model No. QQ-2L

Intelligent Automatic Vacuum Cleaner

INFINUVO

CleanMate 365

Intelligent Automatic
Vacuum Cleaner

Model No. QQ-2L

USER MANUAL

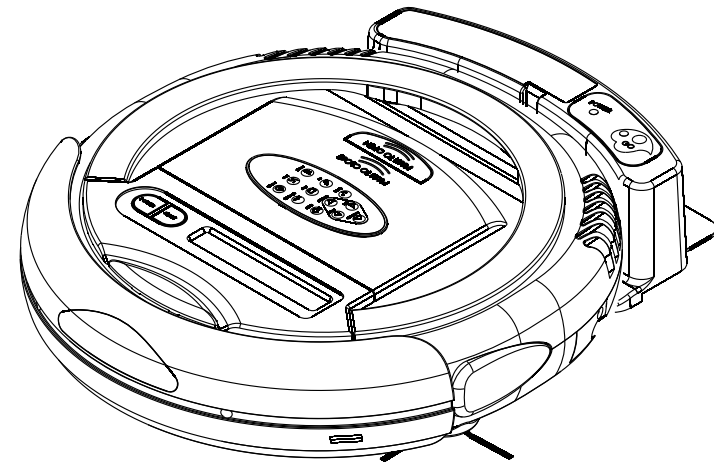

Table of Content

Safety Precautions	1
Safety Instructions	1
Special Features	2
Cautions	3
Main Unit and Accessories	4
Main Unit Features	5
Remote Control Functions	7
Battery Installation and Removal	8
Self Charging Home Base	9
Installing Basic Accessories	10
General Operation	12
Cleaning and Maintenance	13
QQ-2L Useful Tips	17
Specification	19
Troubleshooting	20
Warranty Policy	21

Before using this product, please read the following safety instructions and keep this operation manual for future reference.

Before using this product, please follow all normal safety precautions to avoid the occurrence of situations such as fire, short-circuit, and injury. Please make sure that you observe all the following safety precautions:

Safety Instruction

1. Read this user manual thoroughly before using this product.
2. This product is not for use outdoors.
3. This product is an electronic device. Never get it wet or let it come in contact with water. Do not use it in a moist or wet environment. This is to prevent damage to the electronics in the unit.
4. Before using this product, please tidy up things on the floor. You must remove all objects that could get caught in the rolling brush or in the air intake on the bottom of the unit. Examples include, clothing, power cords, cable, telephone cords, drapes or blinds, loose fringes of rugs. These items can get caught in the unit, and either prevent it from moving, or the unit could pull over a lamp, table, or chair (for examples) and cause damage to the unit, floor, object, or person.
5. Please do not sit or stand on this product. Pay special attention to toddlers or pets in the house to prevent harm to the unit or the child, pet or the unit.
6. Please do not use this product to clean a still-burning cigarette, a lit match or burning embers.
7. Please do not use this product to clean flammable or highly volatile liquids such as gasoline or white gasoline.
8. To prevent damage to the vacuum, make sure that nothing is obstructing the air vents on the top of the unit.
9. When not in use for long periods of time, the power switch must be turned off.
10. When using rechargeable batteries, please use the correct voltage and current listed on the product. If you are not sure about the standard voltage, please ask your distributor or query the local electricity company.
11. Use the factory-provided batteries and charger.
12. When your hands are moist, do not touch the battery charger, plug or power cord.
13. When you need to clean this product, stop charging, and remove the Battery.

Special Features

CleanMate 365

1. This product is a groundbreaking, revolutionary automatic vacuum cleaner. It utilizes high vacuum suction, a rolling brush on the bottom, a side brush for cleaning along walls and other objects, an ultraviolet light to help with disinfection, and even has a compartment for adding fragrance to the air as it cleans. All of these features make this unit perfect for cleaning a wide variety of floor types, including ceramic tile, hardwood, vinyl and most carpets. As long as you have the CleanMate 365 Intelligent Automatic Vacuum Cleaner, you have the most helpful house cleaning mate.
2. The compact shape enables this unit to clean under beds, tables and other furniture that standard upright vacuums cannot get to.
3. Once the CleanMate 365 is turned on, it will follow a five step repetitive movement: Special bounce, Spiral, Along Wall, "S" shape, and Polygonal Spiral. This wide variety of movement helps to ensure that the unit completely cleans a room.

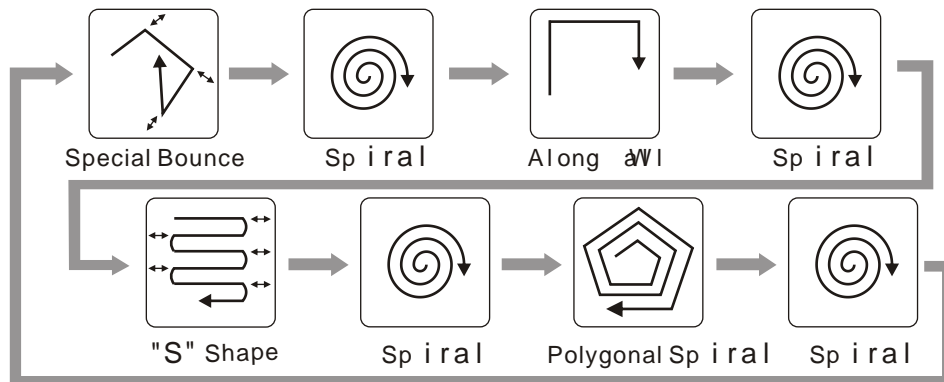

4. "MODE" button on the remote control allows you to select a specific cleaning pattern for the QQ-2L. By default the unit operates in Automatic Mode (switching between all 5 patterns), but by using the "MODE" button on the remote, you can select a specific pattern in the following sequence: 1. Spiral 2. Special Bounce 3. Along Wall 4. 'S' Shape 5. Polygonal Spiral and back to A. Automatic.
Note: when mode 4 "S" shape is in use, if QQ-2L gets stuck in the corner, please use remote control to switch it to another mode QQ-2L will change into other mode automatically in 30 sec).
5. Sensors at the front and sides of the unit tell the CleanMate 365 when it comes in contact with a wall or other obstacle, to back up, turn and clean around the object.

Special Features

CleanMate 365

6. The CleanMate 365 is equipped with a light sensor. When the battery is low, or the cleaning time is completed, the unit will automatically search for the docking station to recharge. If QQ-2L can not find the docking station in 30 minutes, QQ-2L will stop and turn into "sleep" mode automatically which is to prevent battery run out.
7. There is a transparent window on top of the dust bin. This allows you to easily see how full the dust bin is, so you can clean it out when it is needed. This window also doubles as a holder for the remote control to help prevent misplacing or losing the remote control.
8. Photo sensors on the underside of the front of the unit detect stairs, and other drop offs, to keep it from falling off the edge and damaging the unit or anything else.
9. A handle is built-in to the unit to make it easy to pick up and move the unit to a different room.

Cautions

CleanMate 365



Do not look directly at the UV light.



Do not attempt to remove or replace the UV light. This light is a permanent fixture and cannot be replaced. Do not touch the UV light bulb with bare hands. Natural skin oils will cause premature failure.



Make sure the battery is installed correctly.

Main Unit and Accessories

CleanMate 365

Item	Description	QTY
1	QQ-2L Main Unit	1
2	Remote control	1
3	Filter	2
4	Rechargeable battery	1
5	Charger	1
6	Usermanual	1
7	Hand brush	1
8	Self charging base	1
9	Fragrance (purchase by customer self)	1

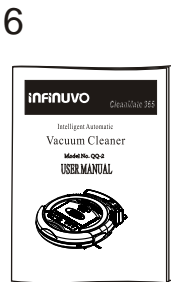
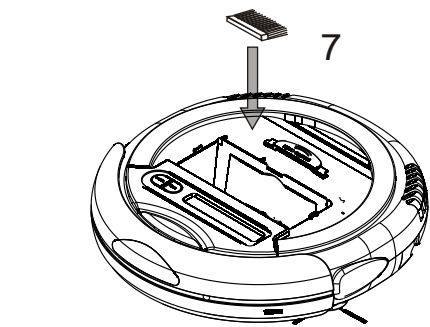
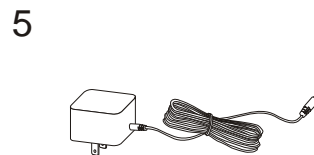
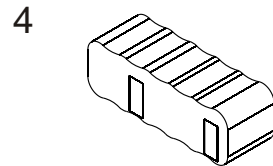
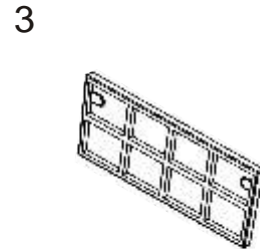
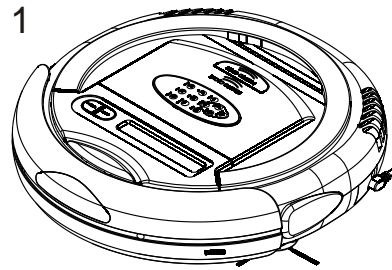

Main Unit Features

CleanMate 365

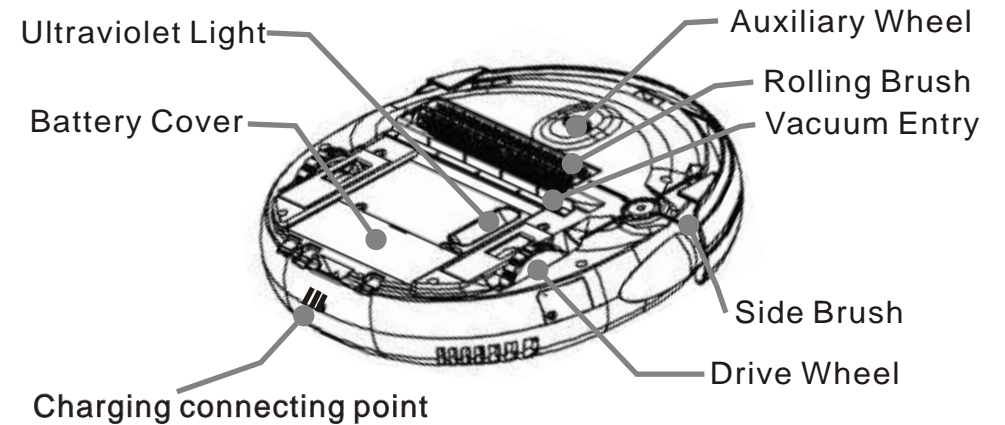
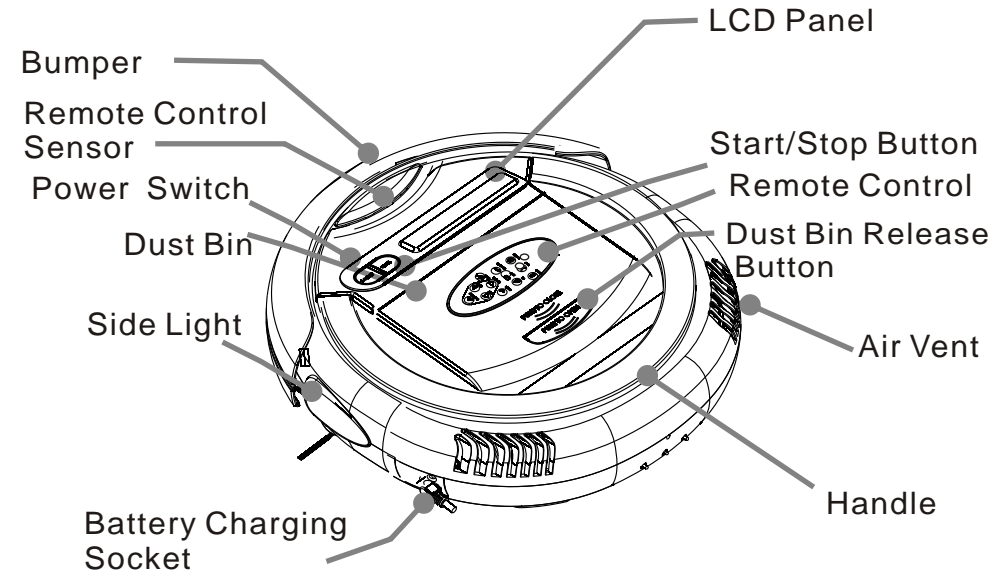

LCD Control Panel

The LCD control panel on the robot shows more clearly the functions that are activating

- ① Power Button: Turn on QQ-2L
- ② Start Button: Start QQ-2L
- ③ Time and Mode Indicator: Demonstrate the time left to clean and the specific cleaning pattern chosen
- ④ Auto: Light up when the cleaning patterns are repeated automatically
- ⑤ UV: Light up when the UV light is activated
- ⑥ Start: Light up when QQ-2L started working
- ⑦ Vacuum: Light up when the vacuum is activated
- ⑧ Battery indicator:

Battery Indicator	Battery Status
Three Cells	Fully Charged
One Cell	Low Battery
Blinking	Charging

- ⑨ Error: Light up when QQ-2L flips or gets stuck

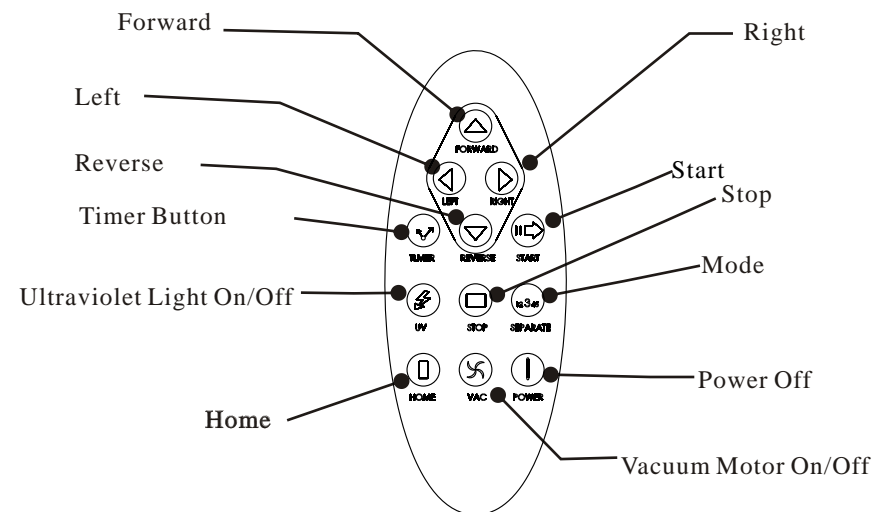
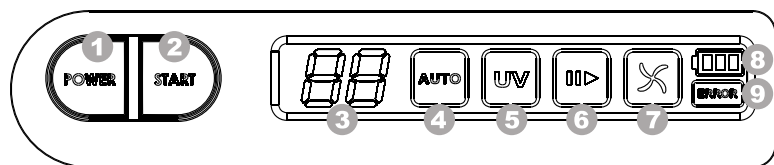

Function of each Button:

1. Start Button: Press the Start Button to begin the automatic cleaning of the room.
2. Stop Button: Press the Stop Button to stop the activity of the unit, and it will emit a long sound.
3. Timer button: Use this button to set the cleaning time of the QQ-2L.
4. Directional Buttons: Forward: when pressed forward QQ-2L will move until user presses forward button again or stopped by obstacle.
Right, left and backward button: use these buttons to manually drive the unit to the right, left and backward.
5. Mode Button:
Select specific cleaning pattern. Cleaning pattern selected will show on the LCD panel with following codes.
F1 Spiral mode (QQ-2L will stop when it comes in contact with any objects)
F2 Special bounce mode
F3 Along wallside mode
F4 S shape mode
F5 Polygonal mode
FR Automatic repeating mode
6. UV button: Allows you to turn On and Off the ultraviolet light as needed.
7. Vacuum Motor Off button: Press this button to control the On/Off of the vacuum motor.

Remote Control Function

CleanMate 365

8. Home button: Use this Button to make QQ-2L go back to the charging base.
9. Power off Button: to power Off QQ-2L manually by pressing Power Off button. Note: QQ-2L Power-on button is on the main unit.

Battery Installation and Removal

CleanMate 365

1. Make sure that the power of the unit is turned 'OFF'.
2. Use your fingers to depress the tabs at the front of the battery cover. Lift up the battery cover by these tabs as shown in Illustration 1.
3. Make sure the battery is inserted in the correct orientation by aligning the silver strips on the Battery with the metal tabs on the inside of the battery compartment. See Illustration 2.
4. Close the battery cover by first inserting the tabs into the slots at the back of the unit, and then pressing down on the front side of the battery cover until the plastic tabs click in place. Please see Illustration 3.

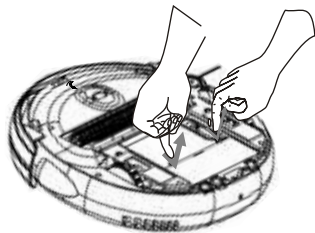

Illustration 1

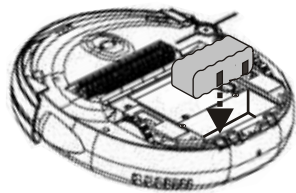
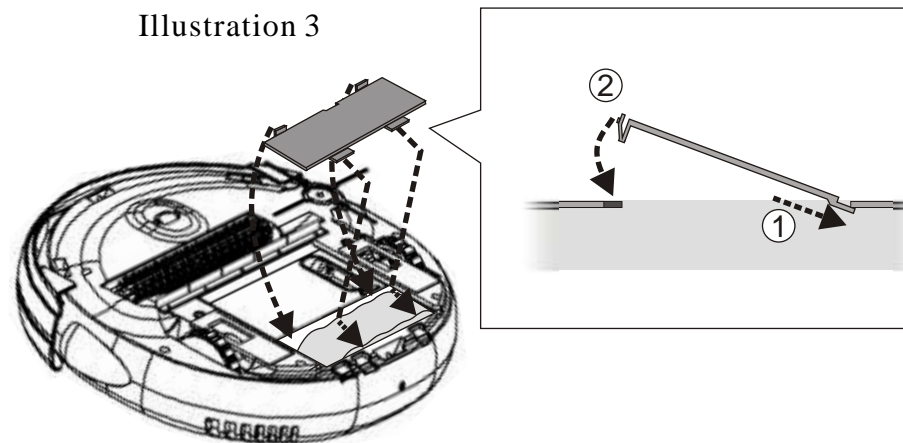

Illustration 2

Battery Installation and Removal

CleanMate 365

Illustration 3



Self - Charging Base

CleanMate 365

The battery needs around 3.5 hours to be fully charged.

1. POWER Indicator (Blue LED light): This light is *on* when the Self-Charging Base is powered on.
2. GO Indicator (Green LED light):
 - A. If you want the QQ-2L to perform cleaning again after being fully charged, press "GO" button once. Make sure the "GO" light is *on* to confirm your setting.
 - B. After the QQ-2L is completely charged, you will hear 3 beeping and one long beep sounds, and the QQ-2L will automatically leave the Self-Charging Base to do the cleaning.

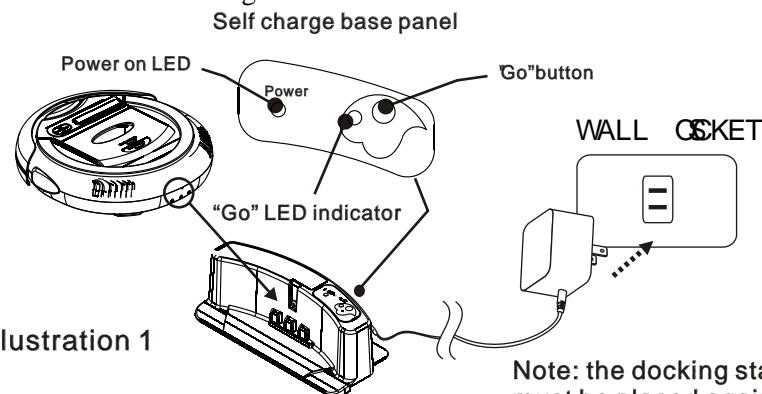

Illustration 1

Note: the docking station must be placed against the wall.

Preparations

1. Find a proper place (we recommend a hard surface floor) to put the Self-Charging Home Base in the room. Leave about 20 inch (50 cm) clearance around the Home Base.
2. Align the metal plate under the Base with the wall. Plug the charger to AC power outlet, and the other end to the DC input connector on the back of Home Base. Do not leave loose wires around the Home Base.
3. Make sure the blue LED light on the Home Base is on. This means that the Home Base has been powered on, and it is ready to charge the QQ-2L.

Testing the Home Base

1. Put the QQ-2L on the floor close to the Self-Charging Base. Turn the QQ-2L on by pressing its power switch button. Now press the "HOME" key on remote control unit. The QQ-2L should return to the Home Base automatically for self-charging.
2. Make necessary adjustment to the Home Base if the QQ-2L cannot dock on the Home Base properly.

Using the Home Base

1. When its battery is running low, or after it has finished the cleaning job, QQ-2L will try to automatically return to the Home Base to re-charge itself. In case the QQ-2L is unable to find the Home Base before battery power is depleted, you can always charge it manually. Just un-plug the AC adapter from the Home Base, and plug it to the DC input connector on QQ-2L.
2. When you charge the QQ-2L manually, the battery will be charged no matter the QQ-2L is on or off.
3. If you press "GO" key after the automatic self charging process, the cleaning time setting on QQ-2L will be re-set to 40 min.

Side Brush Installation and Removal

- To remove the Side Brush, use a Philips head screwdriver to remove the screw in the center of the Side Brush Assembly by turning it counter-clockwise.
- To install the Side Brush, place the Philips head screw through the center hole of the Side Brush assembly, and align the screw with the hole in the slot for the Side Brush. Attach the screw by turning it in a clockwise direction, until the screw is firmly in place.

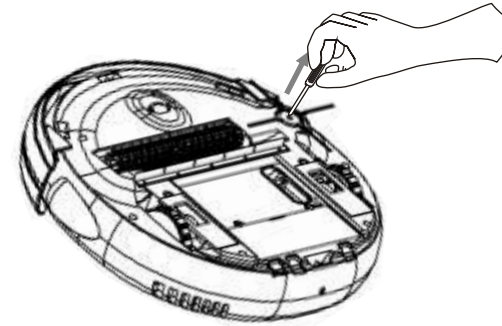

Rolling Brush Installation and Removal

Ensure that the power switch of the unit is set to the 'Off' position, and turn the unit over on its top, with the back of the unit facing you. Align the slotted end of the rolling brush with the slot in the flexible insert in the right side of the rolling brush compartment (near the side brush) and press it into place. Press the free end of the rolling brush down into the rolling brush compartment, and align the free end with the plastic insert on the left side of the compartment. Slide the rolling brush to the left to secure it in place.

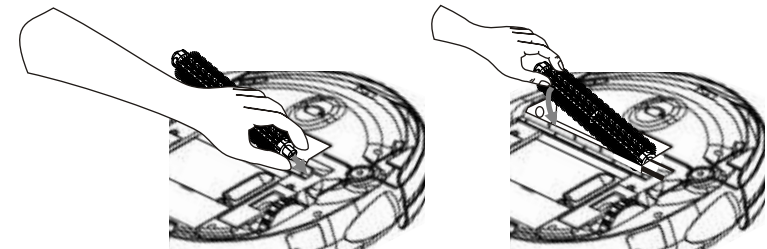

Fragrance Installation and Removal

This Intelligent Automatic Vacuum has a compartment built into it for adding fragrance to the air as the unit cleans. Any solid scent packet, insert, or dryer sheet can be used.

- DO NOT use any type of Liquid or Oil Fragrance with this unit.
1. Press the "Dust Bin Release Button" to release the dust bin cover. See the arrow in Illustration 1.
 2. Remove the dust bin cover as shown in Illustration 2.
 3. Remove the dust bin from its compartment as shown in Illustration 3
 4. Place the fragrance pack into the compartment as shown in Illustration 4.

Installing Basic Accessories

CleanMate 365

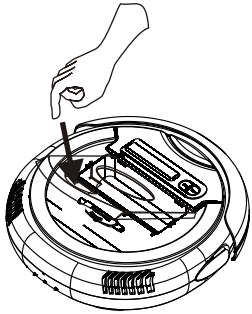

Illustration 1

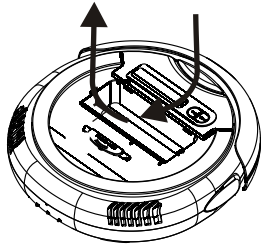

Illustration 2

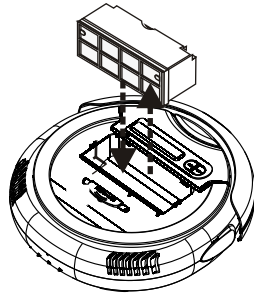

Illustration 3

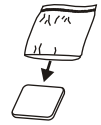
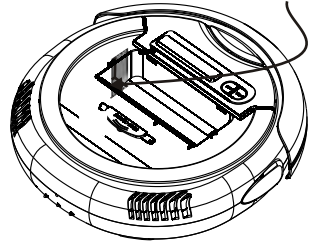

Illustration 4



General Operation

CleanMate 365

1. Make sure you have completely charged the unit before using it for the first time.
2. Room preparation:
 - A. Pick up all large items off of the floor that could get stuck in the brushes or the vacuum intake.
 - B. Pick up/hide all cords that could get tangled in the unit.
 - C. Move all items that could be easily knocked over.
 - D. Roll under loose edges of rugs with any type of stringy fringe.
3. DO NOT use the QQ-2L on plush or long pile carpet or rugs.

General Operation

CleanMate 365

4. When using the QQ-2L in a room for the first time, watch how it operates in the room. Watch for areas that the unit has troubles operating in, and either block these areas of the room or move objects around so that the unit can clean effectively and not get stuck or hung up before it is able to clean the entire room.

Starting Operation

1. Clean out the dust bin before use.
2. Place the QQ-2L on the floor in a relatively open space near the middle of the room to be cleaned.
3. Press the power button on the main unit to turn it on.
4. Set the timer of the unit to the desired cleaning time by pressing the Timer button on the control panel of the main unit or on the remote control.
For Reference: Use 10 minutes of cleaning time for Every 54-72 square feet of floor space. Cleaning time may vary depending on the type of floor being cleaned.
5. Press the Start button on the control panel or the remote control. After a short delay, the QQ-2L will begin to automatically clean the floor.
6. At the end of the cleaning cycle, the QQ-2L will emit a long beep and will turn off the vacuum moto and start to search for docking station.
If the low battery light on the unit is blinking, then the battery is low and QQ-2L needs to be recharged before it can be used again.

Stopping Operation

1. Press the Start/Stop button on the control panel of the unit.
2. Press the Stop button on the remote control.

Cleaning and Maintenance

CleanMate 365

Cleaning and Maintenance

- The operation and maintenance of the QQ-2L is very simple, but to achieve good performance of the unit, it is recommended that you follow a routine cleaning and maintenance schedule.
1. Make sure to clean out the Dust Bin and to brush off the Air Filter after every cleaning cycle.
 2. Make sure that the vacuum intake is free of any obstructions.
 3. Check to make sure that the bristles of the Side Brush are free and not tangled.
 4. Make sure that there is not a lot of hair, string, etc caught up in the Rolling Brush or the wheels.
 5. Remove and clean out the Rolling Brush.
 6. Make sure that there is nothing block the air ventilation slots on the top of the unit.

Cleaning Dust Bin and Air Filter

1. Make sure the power to the unit is 'Off'.
2. Press the Dust Bin Open Button. Illustration 1
3. Remove the Dust Bin Cover. Illustration 2
4. Remove the Dust Bin from its compartment by placing your finger(s) in the groove near the front of QQ-2L, and on the tab at the center of the air filter. Squeeze to disengage the tab, and then lift the Dust Bin straight out of its compartment. Illustration 3
5. Remove the Air Filter from the Dust Bin by firmly holding the Dust Bin in one hand, and pulling the Air Filter straight out by the tabs on the Air Filter. Illustration 4
6. Empty the contents of the Dust Bin into a trash can. Illustration 5
You may rinse out the Dust Bin with water if you need to. Illustration 6
Allow the Dust Bin to completely dry before using it again.
7. Using the Hand Brush that is provided with the unit, brush off the dirt and debris on Air Filter into a trash can. Illustration 7
The Air Filter can be rinsed with water.
Make sure the Air Filter is completely dry before using it again.
8. DO NOT clean the Dust Bin or the Air Filter in a Cloth Washing Machine or a Dish Washing Machine.
9. While the Dust Bin is removed from its compartment, turn the unit over, and using the Hand Brush provided with the unit, brush away any excess dust that might have accumulated in the compartment into a trash can.
10. Once the Dust Bin and Air filter are completely dry, put the Air Filter back in place on the Dust Bin. Illustration 8. Then put the assembled Dust Bin and Air Filter back into the Dust Bin compartment, with the air filter pointed away from the control panel. Illustration 9
11. Put the Dust Bin Cover back in place by first inserting the tabs on the cover into the slots on the case of the unit, then press down firmly on the ridges of the Dust Bin Cover until the Release Button clicks into place. Illustration 10. Make sure the Dust Bin Cover is securely in place before operating the unit.

Illustration 1

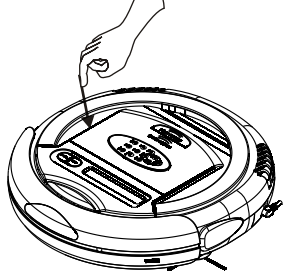

Illustration 2

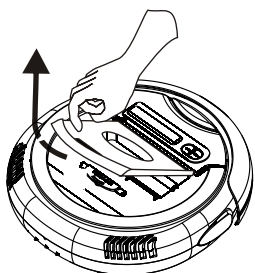

Illustration 3

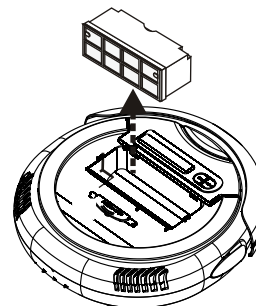

Illustration 6

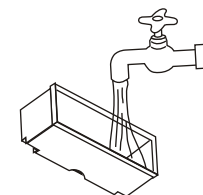

Illustration 8

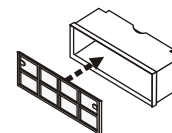

Illustration 4

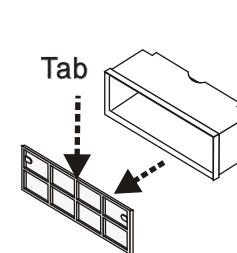

Illustration 9

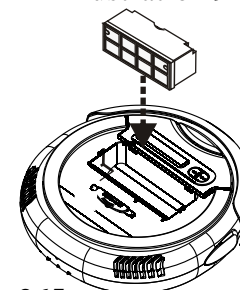

Illustration 5



Illustration 7

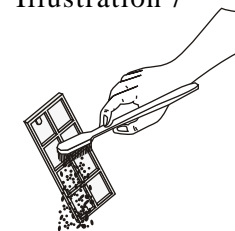
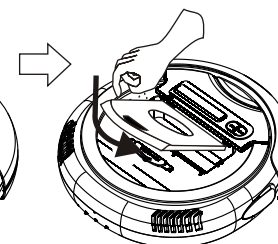

Illustration 10



Cleaning the CleanMate 365

Over time dust and dirt can accumulate in different areas of the unit, DO NOT use Water to clean the unit itself! This is an electrical unit, and if any of the electric components get wet, the unit will no longer work, and could cause a short circuit and potentially hurt someone. Use Canned Air, the Hand Brush provided with the unit, or a dry cloth to wipe away accumulated dust and dirt. After operating the machine for a period of time, dust and dirt will accumulate on the vacuum entry on the bottom of the QQ-2L. Cleaning this area regularly will help ensure that the unit performs properly.

1. Make sure the power of the QQ-2L is turned off.
2. Turn the unit upside-down, and brush any dust that has accumulated inside the vacuum entry as shown below. Shake the dust out into a trash can.

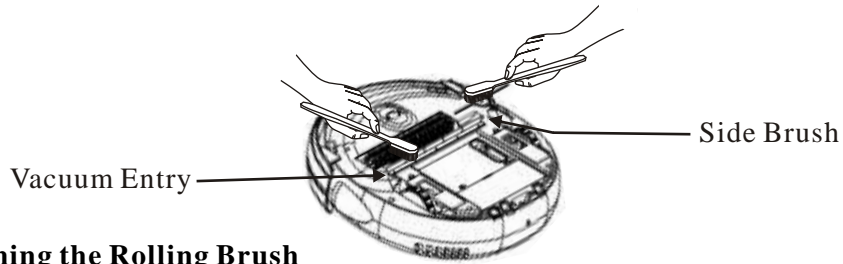

Cleaning the Rolling Brush

Hair and other stringy items can get caught in the rolling brush over time.

1. Make sure the power to the unit is turned off.
2. Turn the QQ-2L upside-down and place it on a flat surface with the back of the unit facing you.
3. Remove the Rolling Brush from its compartment by grasping the left side of the Rolling Brush, and sliding it toward the right.
4. Lift the free end of the Rolling Brush out of the compartment, then slide the Rolling Brush to the left, freeing it from the flexible insert.
5. Manually remove any hair, string or other objects from the rolling brush to ensure proper performance of the unit.
6. With the Rolling Brush removed, loosen any dirt that has accumulated in the Rolling Brush compartment with a brush, then dump the dirt into a trash can.
7. Re-install the rolling brush following the steps outlined in Rolling Brush Installation and Removal

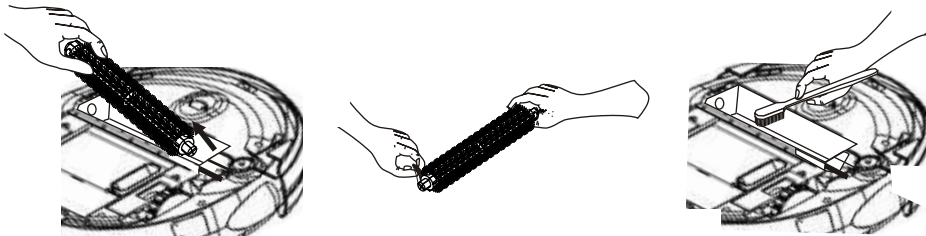

Tip#1: Clear the area where the QQ-2L is to clean of any items can be easily knocked over or caught in the Rolling or Side Brushes.



In the area where the QQ-2L operates, it might knock over items such as vases, glasses, or lamps.



In order to provide the QQ-2L a space for fast and safe cleaning, please remove small items from the area before operating.

Tip#2 Adjust the distance between furniture, walls and other objects to be at least 36 cm (14 in).

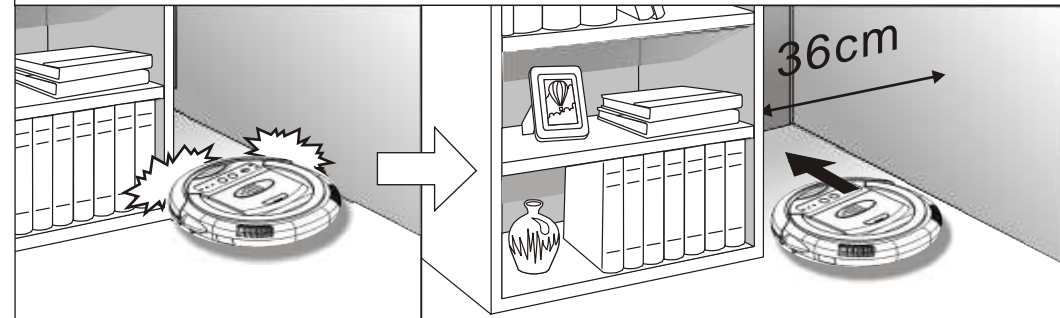

Tip#3 Do not let the loose edges of rugs, drapes, table cloths, etc to get caught in the QQ-2L. Roll under the loose edges of rugs and make sure that any table cloths, drapes, bedding etc do not hang down to the floor.

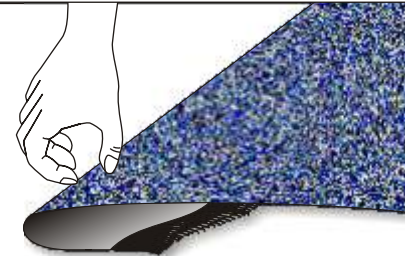

When the QQ-2L is cleaning rugs, fold under the edges of the rug.

Remove plastic bags and leftover long-shaped garbage

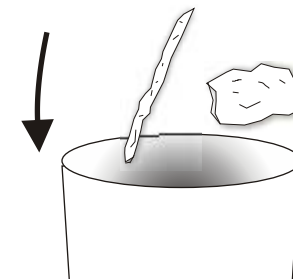

QQ-2L Useful Tips

CleanMate 365

Tip#4 Fixing jams: Objects can get caught in the Rolling Brush and prevent it from working properly. Immediately turn the unit off, clear the object causing the jam, and resume normal use.

When something is jammed inside the QQ-2L, It will emit a beeping sound.

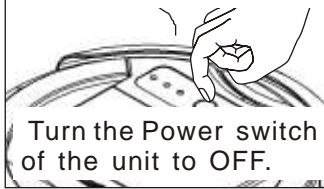

Turn the Power switch of the unit to OFF.

Turn the QQ-2L upside-down, and remove the objects.

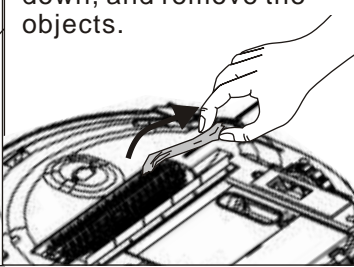

Clean the vacuum entry.

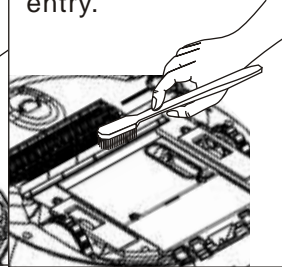

Tip#5 Block areas where the QQ-2L could get stuck by placing objects in the way so that the QQ-2L does not go into these areas.

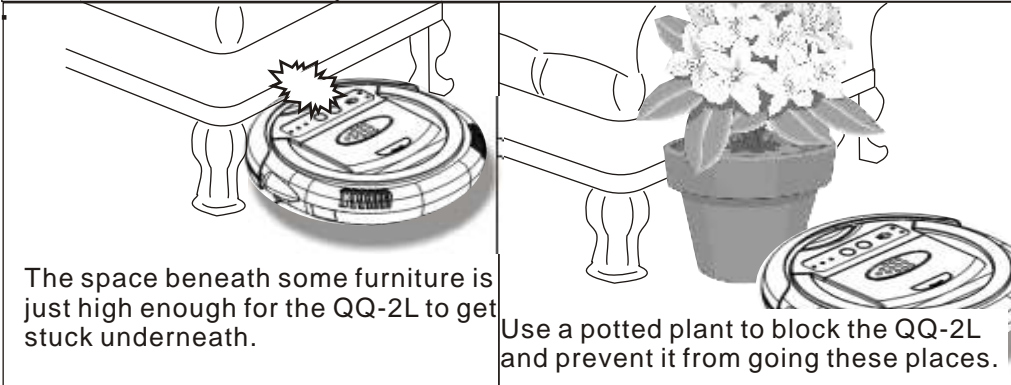

The space beneath some furniture is just high enough for the QQ-2L to get stuck underneath.

Use a potted plant to block the QQ-2L and prevent it from going these places.

Tip#6 Aim the remote control at the sensors on the front of the QQ-2L. Anything blocking the signal will affect the performance of the remote control.

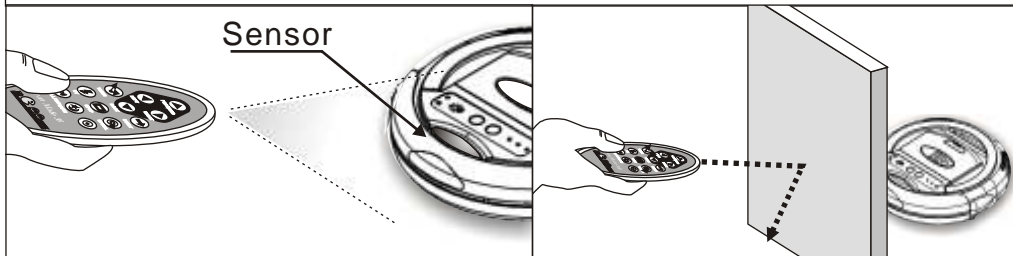

Specification

CleanMate 365

Specification

Item	Description
1	Battery type Ni-MH 2500
2	Fast adapter/charger 20Vdc 1000mA switching 3.5 hours of charging time
3	Battery Ni-MH 14.4V, 2.5Ah Rechargeable
4	Life time of UV ray 6000 hours continuously
5	Capacity of dust bin 0.3 liter
6	Moving speed of machine 16.5 ~ 18.5 cm/sec
7	Remote control Infra red light with more than 3 meters controlling range, can be embedded directly into upper cover
8	Types of movement 5 types: Spiral, Special Bounce, Along Wall, S shape, Polygonal Spiral
9	Dimension 36cm(Diameter)x 9cm (H) or 11.4inch (diameter) x 3.5 inch (H)
10	Weight 3kg

Trouble indication	Possible Cause	Suggested Remedy
Can not power on	No power	1. Make sure the battery is properly installed and fully charged 1. Power on the machine
Remote control no reaction		2. Check whether the remote control's battery is properly installed and in good condition 3. Some of function only can work while the machine is powered on Please read "Remote control function" carefully on the user manual
Error signal appeared	Machine is away from ground over 3 seconds Used wrong AC adapter	1. Put the machine on the ground 2. Check whether the machine was stuck by obstacles 3. Ensure the AC adapter is the original machine's adapter
Bumper is not properly react		2. Stop charging and run out the battery power then recharge again 1. Take off the bumper's protecting sponge

Please fill in your warranty card completely and submit it to your local customer service center.

Infinuvo provides you, as the owner of this Infinuvo product, with the following Limited Warranty Policy.

One year Product Warranty:

Infinuvo warrants to the original purchaser of this Infinuvo product that the product is free from defects in original materials and workmanship for a period of up to one year from the date of initial purchase. This warranty is only valid if the product has been properly installed and is used in the way for which it is intended, and has received only factory-authorized repairs, servicing or alterations.

Under-warranty products that meet these conditions and that function improperly will be repaired or replaced, at the discretion of Infinuvo.

Six months Battery Warranty:

Infinuvo warrants to the original purchaser of this Infinuvo product that the original batteries contained within this product will function for a period of six months. This warranty is only valid if the product has been properly installed and is used in the way of which it is intended, and has received only factory-authorized repairs, servicing, or alterations. Under-warranty batteries that meet these conditions and that function improperly will be repaired or replaced, at the discretion of Infinuvo.

These warranties contain the sole express warranty of Infinuvo, which makes no other warranties, expressed or implied. These warranties are made in lieu of any implied warranties of merchantability or fitness for a particular purpose. These warranties give you specific legal rights. You may also have other rights, which vary from state to state.

WHEN YOU RETURN A CLEANMATE PRODUCT OR BATTERY UNDER THIS WARRANTY, you must first obtain an RMA number by calling your local customer service center. Infinuvo reserves the right to request that you submit a letter describing the circumstances under which the problem occurred and that you submit invoice and any other supporting evidence and documentation.