

ROBOT VACUUM CLEANER

Model No. IQX 510

USER MANUAL

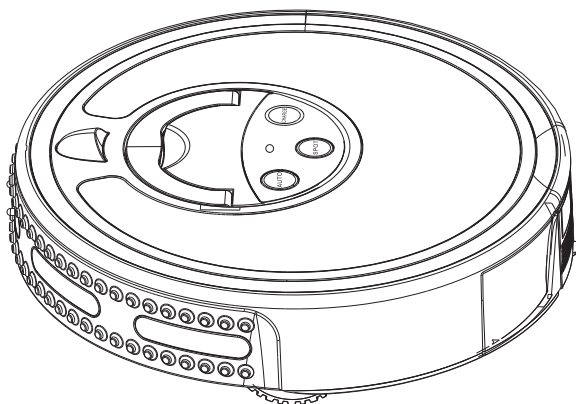

Contents

Contents	01
Applications	02
Main Features	02
Package Contents	02
Introduction	03
Structure Introduction.....	03
Battery Installation & Replacement.....	04
Cleaner Operations.....	06
Manual Charging & Auto Charging.....	07
Remote Control.....	08
Virtual Blocker.....	10
Charging Station.....	11
Maintenance of the Cleaner	12
Dust Bin.....	12
Filter.....	13
Main Brush and Floor Brush.....	14
Front Wheel.....	14
Trouble Shooting	15
Technical Specifications	16
Safety Precautions	17

Applicability:

This robotic vacuum cleaner is designed to be used in homes and small offices. It is not for outdoor use or commercial use. It has excellent cleaning results on various hard floors (wood, tile, stone, vinyl, etc) and short-pile carpets. NOTE: It is not suitable for cleaning plush or long-pile carpets.

Main Features:

This multi-function robotic vacuum cleaner has strong cleaning power. It comes with a user friendly interface to easily perform the following functions.

- Just push one button to do AUTO cleaning, SPOT cleaning or mopping.
- Handy remote control unit with LCD display to control cleaner operations, movements plus cleaning and power it On/Off.
- Easy to set up pre-programmed schedule with remote control to do cleaning any time you want
- When battery power is low, it will return to charging station and re-charge its battery automatically.
- Two movement speeds and easy to read error code on remote to indicate abnormal conditions
- Soft-touched and non-collision obstacle detection to protect furniture in your home.

Package Contents:

1. Main Body x 1pc
2. Remote Control x 1 pc (2 AAA batteries not included)
3. Charging Station x 1 pc
4. Adapter x 1 pc
5. Virtual Blocker x 1 pc (2 AA batteries not included)
6. User Manual x 1 pc
7. Trailing Bar x 1 pc
8. Mopping Pad x 2 pcs (one attached to trailing bar)
9. Dust Brush x 1 pc
10. Side Brush x 2 pcs
11. Filter x 3 pc
12. Rechargeable Battery x 1 pc

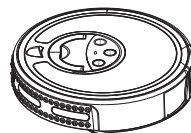

Main Body



Remote Control



Charging Station

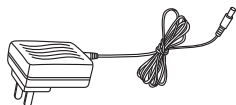

Adapter



Virtual Blocker



User Manual



Trailing Bar with Mopping Pad



Mopping Pad



Dust Brush

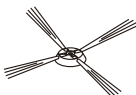

Side Brush



Filter



Rechargeable Battery

Introduction

Main Unit Features

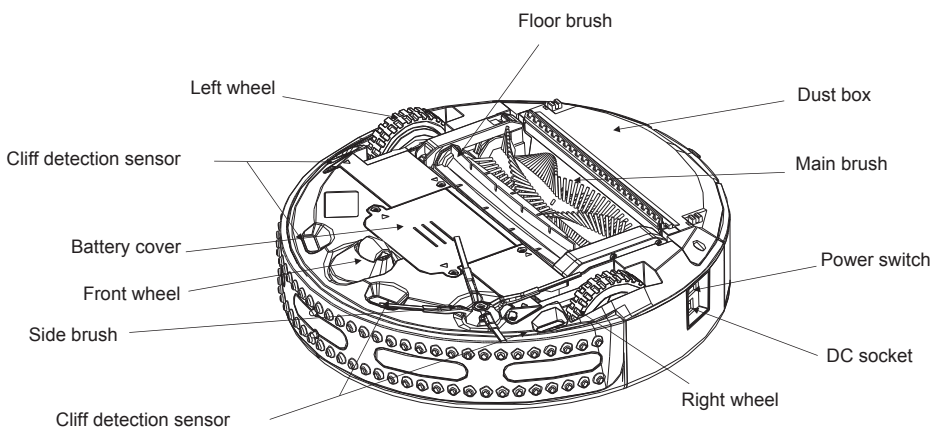
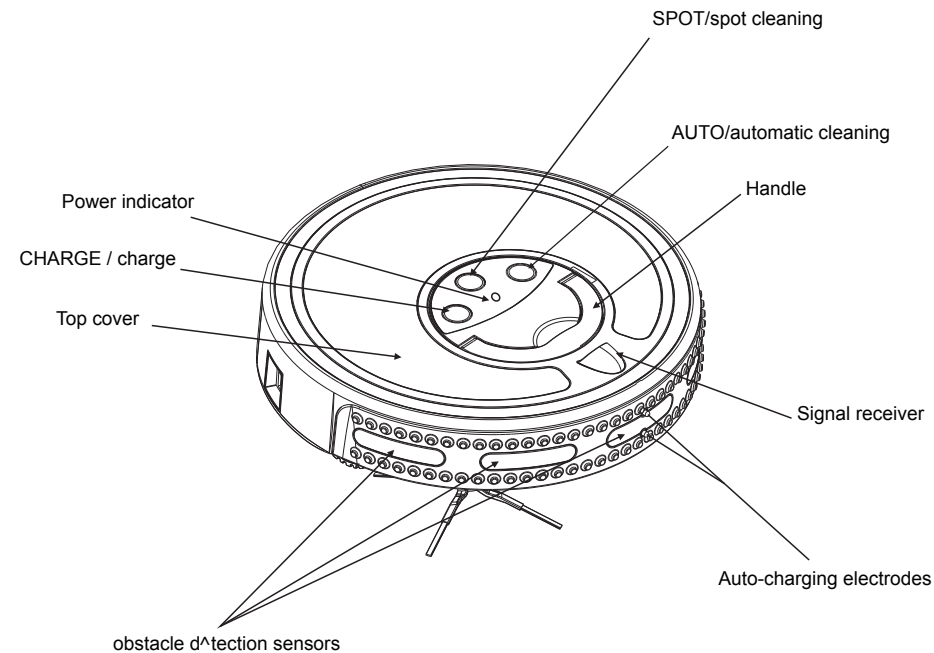

Battery Replacement & Installation

1. Remove 2 screws to open battery compartment door. (See Fig. 1)
2. Connect battery plug to the connector on main unit. (See Fig. 2)
3. Make sure battery polarity is correct to avoid potential damage to the machine.
4. Leave the cleaner in charging status to keep the battery at best performance while not in use.
5. Only use original battery from manufacturer when you replace the battery.

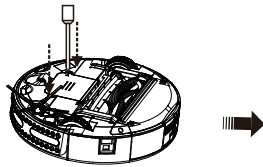

Fig.1

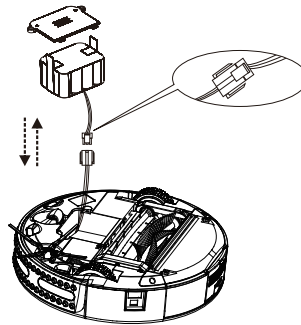

Fig.2



1. Take the battery out if you do not use the cleaner for a long time.
2. Turn off Power before removing battery from the machine.
3. Don't put the battery at hot environment (over 45C/113F) or in the water.
4. Don't apply large external force to battery or drop it from high place.
5. Battery must be recycled. Do not disposal of it in household trash or in fire. Otherwise, it might explode under high heat.
6. In case of battery leakage, don't let the liquid exposed to skin or clothes. Immediately wipe it with dry clothes and send damaged battery to recycling station.
7. Do not use battery from any other suppliers when you replace the battery.
8. To extend battery life, make sure to charge battery manually for 12 hours when you use the cleaner for the first time, or remove battery for storage when you will not use cleaner for a long time. Otherwise, the performance of cleaner will be affected and running time will be much shorter than the normal working time. It normally take a few charging / discharging cycles for the battery to reach peak performance.

Battery replacement on Virtual Blocker:

1. Open battery door (see Fig. 1).
2. Install 2 AA size batteries (not included) in correct polarity (+/-) (See Fig. 2 and Fig. 3)
3. Please take the battery out if the cleaner will not be used for a long time.

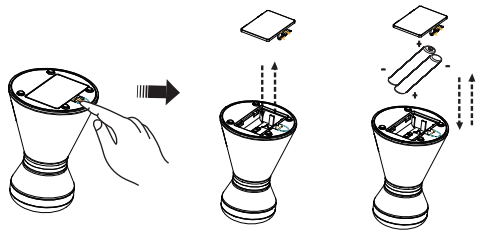

Fig 1

Fig 2

Fig3

Battery replacement - Remote Control:

1. Open the battery door and replace 2 AAA size batteries (not included). (See Fig. 1)
2. Make sure the battery polarity is correct (See Fig. 2)
3. Please take the battery out if your cleaner will not be used for a long time.

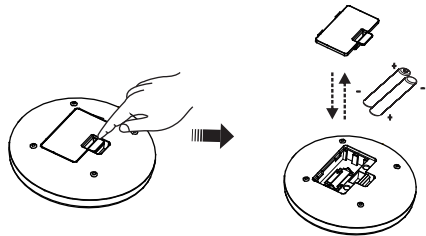

Fig 1

Fig 2



1. Please don't put battery in high-temperature environment (> 45C or 113F) or in the water.
2. Please don't apply large force to the battery or drop it from high place.
3. Battery should be recycled. Please don't discard it in household trash or throw it in fire. It might cause explosion!

Functions of Buttons:

Power Switch (on main unit):

After the cleaner is powered on, it will enter into standby mode, and power indicator light would be on.

Tips:

The power indicator light is on when the cleaner is working;

The power indicator is blinking when battery charging is in progress;

The power indicator will stop blinking after it is fully charged.

AUTO (Automatic cleaning):

Press **AUTO** button on main unit or remote control to let the cleaner start cleaning automatically.

When battery power is low, it will automatically search for charging station to re-charge its battery.

Press any button on cleaner panel to stop the **AUTO** cleaning.

Tips:

When battery power becomes low during cleaning, cleaner will beep for 10 times and automatically search for charging station to re-charge its battery. The **CHARGE** indicator light will also be on.

Before cleaning, you need to clear any clutters on the floor.

SPOT (Spot cleaning):

Press **SPOT** button on main unit or remote control, and the cleaner will automatically clean a 3ft x 3ft area of in spiral mode for about 2 ~ 3 minutes and then stop.

Press any button on cleaner panel to stop **SPOT** cleaning.

Tip:

When battery power becomes low during cleaning, cleaner will beep for 10 times and automatically search for charging station to re-charge its battery. The **CHARGE** indicator light will also be on.

CHARGE (Charging the battery):

Press **CHARGE** button on main unit or remote control, and the cleaner will start searching for charging station to re-charge its battery.

Press any button on cleaner panel to stop it.

NOTE: The default cleaning setting of cleaner is in Fast (moving speed) moving mode.

Press **SPEED** button on remote control to change moving speed (Fast or Slow) based on floor type to be cleaned.

Manual Charging & Auto Charging:

Manual Charging:

1. You can use either AC adapter or charging station to charge the cleaner manually.

2. Method 1: Turn on the cleaner and connect adapter's output plug to the manual charging socket on cleaner (See Fig. 1).

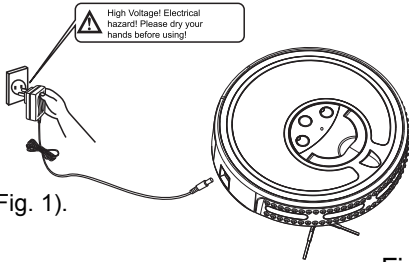

Fig.1

3. Method 2: Before charging, turn on the cleaner and connect adapter to the charging station. Put the cleaner in front of charging station, with the charging prongs on main unit towards charging station. (See Fig 2)

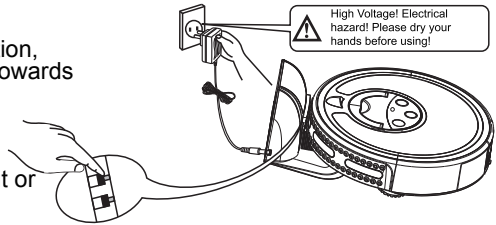

Fig.2

4. Press CHARGE button on the main unit or remote control, and the cleaner will start docking to the charging station and re-charging the battery (See Fig. 3)

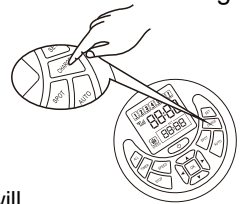

Fig.3

5. When the cleaner is trying to dock to charging station, if you want to stop it, just press CHARGE button on cleaner panel, or press STOP or CHARGE button on remote control.

6. During battery charging process, cleaner's power indicator will blink. The power indicator will stop blinking when battery is fully charged.

Automatic Charging:

When battery power becomes low during cleaning, the cleaner will beep 10 times and it will automatically search for the charging station for re-charging with CHARGE button light on.

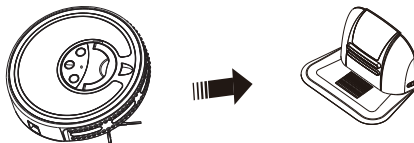

Tip: When it just finishes charging, battery maybe warm or even a little hot. Battery charging time could be longer.

Remote Control:

Control Panel of Remote Control:

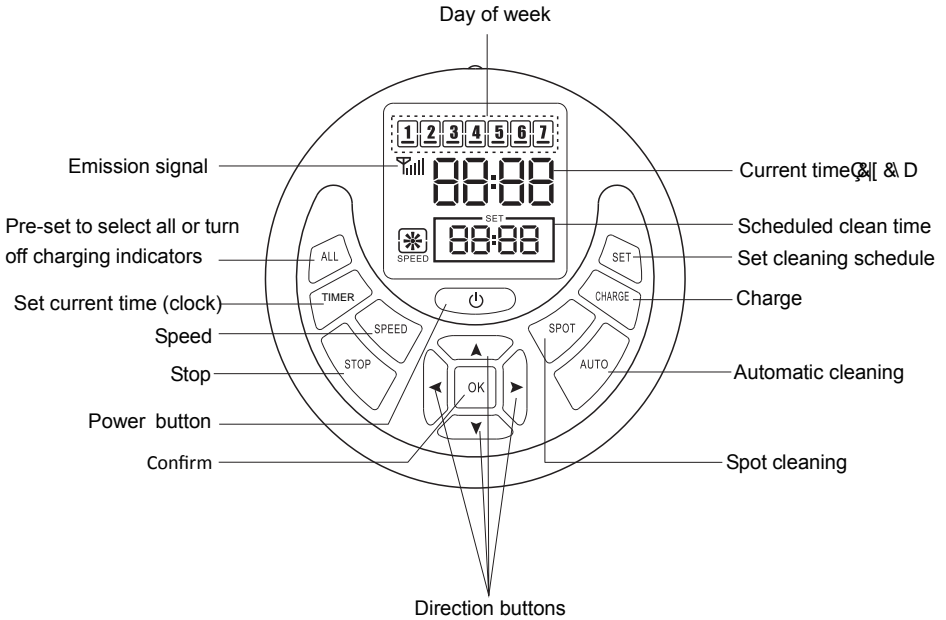

Tips: Code check is required before you use the remote control, or it will fail to work.

Code check steps: Please make sure that both cleaner & remote control have enough power left, then follow the steps below.

A: Turn off the cleaner;

B: Press and hold "OK" button on remote control;

C: Turn on the cleaner;

D: After the cleaner beeps 2 or 3 times, release the "OK" button. The code check is successfully completed now.

★Note: If you do not hear beeping sounds 2 ~ 3 times during the code check process, just repeat above steps.

Functions Introduction of Remote Control:

- SPEED selection: press "SPEED" button on the remote control, you can choose fast or slow speed.



fast speed



slow speed

- TIMER (Setting up clock)

Press "TIMER" button first and then press "◀" "▶" button to move the blinking digit on the remote control screen to switch between hour, minute & "day of week" sections (as shown on Pic 1)

Press "▲" "▼" buttons to change the value and set up

hour, minute & day of week respectively.

★Tip: During the setting, press "⏻" button to quit; press

"TIMER" button to save the current setting.

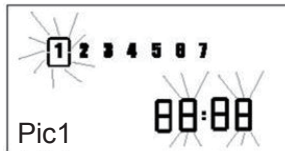

- SET (Set up cleaning schedule):

A: Set cleaning time (hours & minutes):

Press "SET" button first and then press "◀" "▶" the blinking digit on remote control screen will switch between hour, minute & "day of week" sections (as shown on Pic 2).

Press "▲" "▼" to change the value and schedule

a time that you want the unit to start cleaning.

B: Set cleaning day(s) of week:

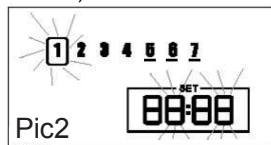

In "day of week" section, press "OK" to select the day: 1 2 3 4 5 6 7 "

The selected day will have a "bar" under it. 1 2 3 4 5 6 7 "

Press "ALL" button to select all days of the week



, press it again to clear

all 1 2 3 4 5 6 7

★ Tip: During the setting, press the "⏻" to exit (not save setting); press "SET" to save current setting.

"FULL CHARGE& GO" FUNCTION

1. Press "SET" button, remote control screen will show a blinking digit 00:00. Press "STOP" and you will see "FFF:00" displayed with the first letter "F" blinking. Press "SET" again it will stop blinking. This indicates that "FULL CHARGE& GO" function has been activated. The cleaner will automatically start cleaning once its battery has been fully charged on the charging station.

2. To cancel the "FULL CHARGE& GO" setting, first press SET button to have "FFF:00" displayed on remote control screen with first letter "F" blinking, then press STOP. Now, press SET button again and the "FULL CHARGE& GO" setting is cancelled.

★Tip: When "FULL CHARGE& GO" function is set, the scheduled cleaning function will NOT WORK.

Virtual Blocker:

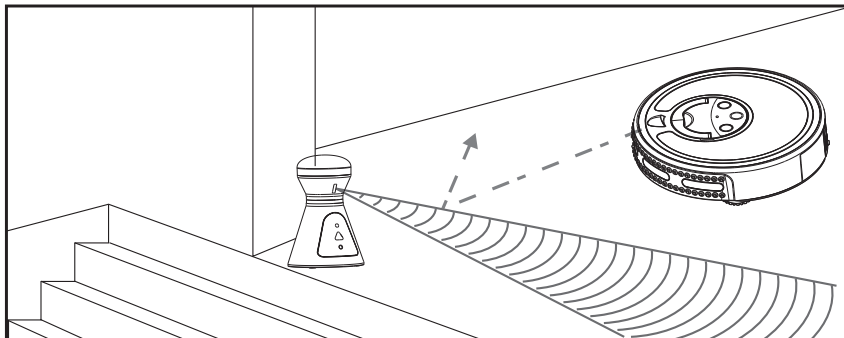
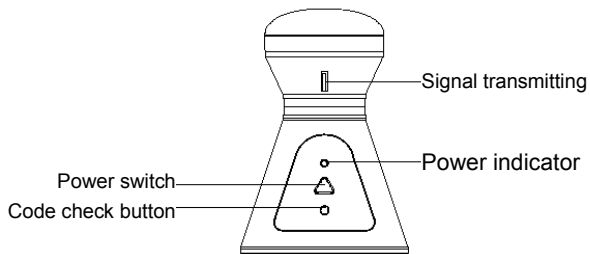

Tip: You should perform code check before using Virtual blocker; otherwise it will not work.

Code check steps:

- A : Turn off the cleaner first, and turn on the Virtual blocker (with power indicator on);
- B : Keep holding the code check button on the Virtual blocker; (Tip: the code check button is inside a hole, so you need to use a tool to press it down)
- C : Turn on the cleaner;
- D: After the cleaner beeps 2 or 3 times, release the code check button. The code check is successfully completed now.

★ Note: If you do not hear the sound 2 or 3 times during the code check process, just repeat above steps.

Tip : It is better to put virtual blocker against the wall, or it might be pushed by the cleaner from the side or the back of virtual blocker, which may let the cleaner across the confined area.

Charging Station:

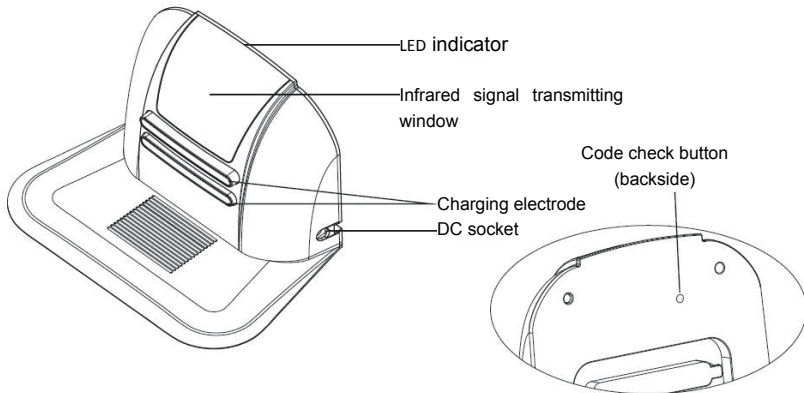

Tips: Before you use the charging station, code check is required. Otherwise, it will not work.

Code check steps:

A: Turn off the cleaner;

B: Press and hold the code check button of docking station; (Tip: code check button is inside a hole, so you need to use a tool to press it down)

C: Turn on the cleaner;

D: After the cleaner beeps 2 or 3 times, release the “OK” button. The code check is successfully completed now.

★ Note: If you do not hear beeping sounds 2 or 3 times during code check, just repeat above steps.

Tip: It is better to put charging station against the wall, or it might be pushed by cleaner from the side or back of charging station, which could cause docking troubles.

Automatic Charging:

1. Put the docking station on a hard, leveled surface against the wall. (See Fig. 1)

2. No obstacle or hollow area 10 ft away in front of the charging station, or 2 ft away on the left & right of it.

(See Fig. 1)

3. The cleaner can not find the docking station for re-charging if the IR infrared signal window on docking station is covered or blocked.

4. Connect the plug of AC adaptor to the input socket on charging station. (See Fig. 2)

5. LED indicator status:

A: During charging process, LED indicator light blinks once per second.

B: In standby status, LED light will change from bright to dark.

Tip: Press “ALL” button on remote control to turn off the LED light.

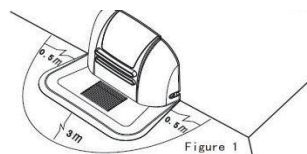

Figure 1

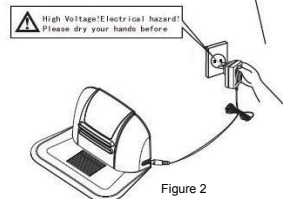

Figure 2

Maintenance of the Cleaner:

Removal of Dust Bin:

- A. Hold the bottom of cleaner with your hand, and press the release button on dust bin (See Fig. 1)

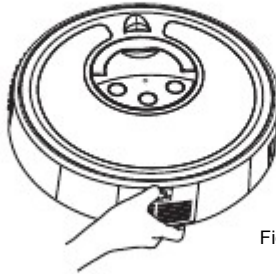

Fig. 1

- B. Remove the dust bin from cleaner. (See Fig. 2)

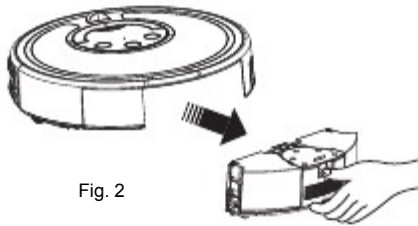

Fig. 2

Note: To re-install it, just push the dust bin back into place.

Cleaning of Dust Bin

- A. Move the two side clips on the dust bin, open the fencing plate and pour out debris & dust (see Fig 1);
- B. Clean it with included cleaning brush (see Fig 2).

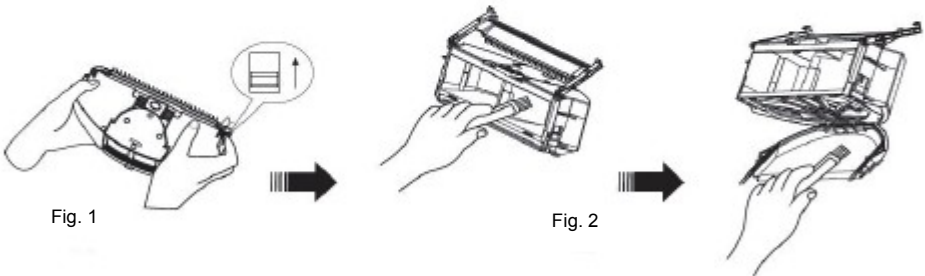

Fig. 1

Fig. 2

Filter Replacement & Cleaning:

- A. Press the two side clips over the dust bin to open the fencing plate. If the rubber part attached to fencing plate is worn out, you need to take it out and replace it.
(See Fig. 1)

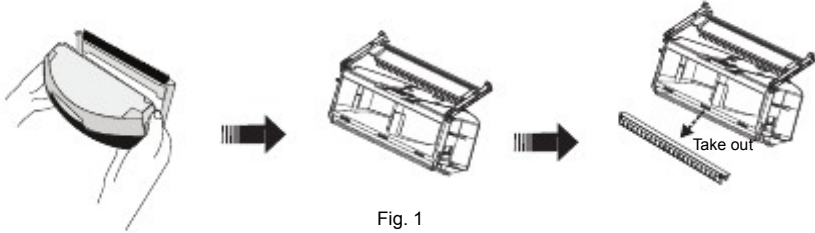

Fig. 1

- B. Press the button on dust bin, the fan assembly will automatically pop up
(see Fig. 2);

Tip: Do NOT let water get into the fan assembly when you clean it.

- C. Pop up the blower motor (optional), remove the filter, and clean the dust bin. (see Fig. 3)

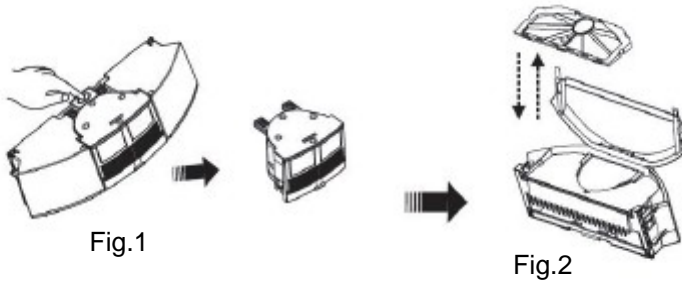

Fig.1

Fig.2

- D. Clean the filter by hair dryer with cold wind or using brush cleaner. (see Fig 4 and Fig 5)

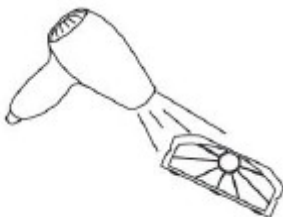

Fig. 4

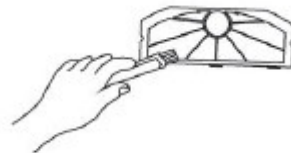

Fig. 5

- E. Re-install the filter.

Tip: Sometimes, the rubber cleaning head might fall off when you clean the dust bin.
Please follow the instruction below to re-install it.

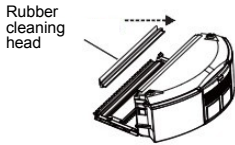

Fig. 1

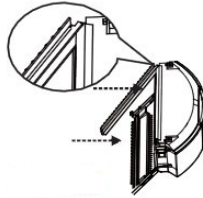

Fig. 2



Fig. 3

1. Put the dustbin and rubber cleaning head in position as shown in Fig. 1.
2. Place one side of the cleaning head into the dustbin first; make sure the cleaning head is upward and connect well with the dustbin. (see Fig. 2).
3. Let cleaning head completely connect to the dustbin by pressing it down with hand.

Install & Removal of Main Brush & Floor Brush:

1. Push the red locking latch on brush holder forward, so you can lift the holder up and open it. Lift the main brush from this side, and pull it out from the mounting hole other the other side (see Fig 1 and Fig 2)

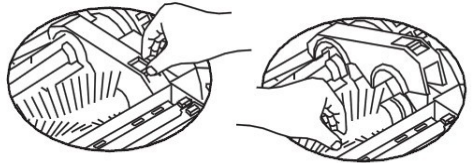

Fig.1

Fig.2

2. Take out both main brush and floor brush in this way. (see Fig 3)

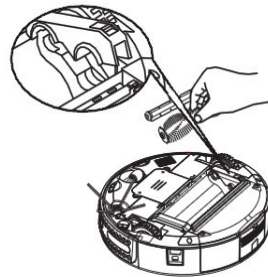

Fig.3

3. Insert new main brush and floor brush to mounting holes, then close the brush hold assembly.

Install & removal of Side Brush:

1. Remove side brush mounting screw first, then take out the side brush.
2. Press the new side brush against the main shaft, and then fasten the screw. (see Fig. 4)

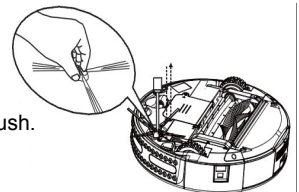

Fig. 4

Cleaning of Main Brush and Floor Brush:

1. To keep your cleaner always working at peak performance, regularly clear hairs and debris around the brushes & wheels.
Clean the dust around the air intake. Rotate the brush slowly and cut any tangled hair and twisted thread, etc with scissors or pull them out.
2. Carefully clean the main brush and floor brush.



Cleaning of Front Wheel:

You can clean the front wheel with a clean brush. (see figure below)



Error code and common solutions:

When cleaner has an error, press SET button twice on the remote control to display the error code. Press POWER button on remote control to clear error code display.

Error Code	Failure Cause	How to solve
E001	Ground detection sensors	Clean the sensors at the front bottom of the cleaner
E002	Middle brush	Clean the rubbish such as hair, thread wrapped on the brush
E003	Power off	Use the adaptor to charge the cleaner. Use it again after it is fully charged.
E004	Left & right wheel	Check the left wheel & right wheel. Clean them if necessary
E005	Dustin poor contact	Check the dustbin and re-install the dustbin after cleaning



If the problem still exists, please contact the technical support center and warranty provider for further assistance (www.hovobots.com). This cleaner needs to be serviced by professional staffs.
Do not try to disassemble it by yourself.

Technical Specifications:

Main Cleaner Unit

1	Rated Voltage	DC 14.4V
2	Battery	Ni-MH battery (normal charging time: 3~4 hours)
3	Running Time	60 min.
4	Rated Power	24W
5	Operating Temperature	14 to 113 °F
6	Operating Humidity Range	≤ 90% RH
7	Wireless Remote	ISM Frequency Band 2.4GHz
8	Dimensions	12.6 in. (diameter) x 3.6 in. (height)
9	Weight	6.8 lbs
10	Battery Capacity	2200 mAh
11	Dust Bin Capacity	0.35 L

Remote Control:

1	Rated Voltage	DC 3V
2	Battery Type	2 AAA alkaline batteries
3	Effective Distance	up to 23 ft. (no obstruction)
4	Operating Temperature	14 to 113 °F
5	Operating Humidity Range	≤90%RH
6	Wireless Frequency Band	2.4GHz
7	Dimensions	4.3 in. x 1.1 in. (including buttons) (L x W)
8	Weight	2.8 oz

Charging Station:

1	Rated Voltage	DC 24V
2	Dimensions (L x W x H)	8.6 in. x 5.4 in. x 4.9 in.
3	Weight	8 oz
4	Operating Temperature Range	14 to 113 °F
5	Operating Humidity Range	≤90% RH

Virtual Blocker:

1	Nominal Voltage	DC 3V (2x AA Battery)
2	Wireless Frequency Band	2.4GHZ
3	Control Distance	up to 11 ft.
4	Emission power	1 mW (0dB)
5	Operating Temperature range	14 to 113 °F
6	Operating Humidity range	≤ 90% RH
7	Dimension	3.4 in. (diameter) x 4.9 in. (height)

Safety Precautions:



Caution

<p>No one else can disassemble, maintain or transform the product except for qualified technicians designated by manufacturer, or it may cause electric shock or personal injury.</p>	<p>Don't use other charger from other supplier, or it may cause damage to the cleaner.</p>
<p>Don't touch power cord with wet hand, or it may cause electric shock.</p>	<p>Don't over bend the power cord or put large weight on it, or it may cause short circuit damage, fire or electric shock.</p>
<p>Don't let your hand, hairs or clothes touch the running brushes or wheels of the Robot, or it may cause personal injury.</p>	<p>Don't run the cleaner over cigarette, lighter, Match and other hot objects or combustible materials such as gasoline, etc.</p>



Attention

<p>Don't forget to turn off the power when you ship it or put the cleaner in storage, or when battery is damaged.</p>	<p>Make sure the connection of adapter is secure or it may cause electric shock, short circuit, smoking or fire.</p>
<p>Check whether the charger is securely Connected to the charging socket, or it may cause charging failure or sparks.</p>	<p>If the machine will not be used for a long time, remove the battery from the machine and store it in a cool dry place after it is fully charged.</p>
<p>To extend the cleaner's battery life, make sure to charge the battery for at least 12 hours before your first use the machine or when it is not used in long time. It will reach the peak performance after 2 to 3 charging and discharging circles.</p>	<p>Remove all loose & easy to break objects on floor (including luminous objects, fabrics, glass bottles, etc.) before using the cleaner, or it might cause damage to them or affect the performance of the robot cleaner.</p>
<p>Please use the Robot cautiously in the presence of the children.</p>	<p>Don't stand or sit on the Robot, or it may cause damage to the Robot or personal injury.</p>
<p>Don't let the Robot work in area with water & other liquors, or it may cause damage to the product.</p>	<p>Don't use the Robot on small tables and chairs or other small space, or the Robot may be damaged.</p>
<p>Don't use the Robot outdoors, or it may cause damage to the product.</p>	<p>Don't use the Robot in commercial places, or the Robot may be damaged by excessive use and voids the warranty.</p>
<p>Do not leave cord, wire or other objects that is longer than 6 inches on the floor. They may entangle with cleaner's brushes and wheels and reduce cleaning efficiency.</p>	



"CE" marking states that the product is compliant to European Directives:
2006/95/EC Low Voltage Directive
2004/108/EC EMC Directive

It is possible to request a full copy of Declaration of compliance to the Distributor:
This product comply with the rules of RoHs Directive(2002/95/CE)
This product comply with the rules of EupDirective(2002/125/CE)

Contact Technical Service Center (www.hovobots.com) for warranty service.